

KLAPPSCHLOSS CODE/RFID  
SERRURE À VOLET CODE/RFID  
SERRATURA INCASSATA CODE/RFID  
CERRADURA ABATIBLE CODE/RFID  
CLASP LOCK CODE/RFID



CODE Lock



RFID Lock

Benutzerhandbuch  
Manuel de l'utilisateur  
Manuale per l'utente  
Manual de uso  
User handbook

**INHALTSVERZEICHNIS**  
**SOMMAIRE**  
**SOMMARIO**  
**ÍNDICE**  
**TABLE OF CONTENTS**

---

Informationen Informations Informazioni Información Information	<b>3</b>	Programmierung RFID Lock Programmation RFID Lock Programmazione RFID Lock Programación RFID Lock Programming RFID Lock	<b>14</b>
Produktübersicht CODE Lock, RFID Lock Aperçu du produit CODE Lock, RFID Lock Panoramica del prodotto CODE Lock, RFID Lock Vista general del producto CODE Lock, RFID Lock Product overview CODE Lock, RFID Lock	<b>4</b>	Programmierung Funktionen Programmation fonctions Programmazione funzioni Programación funciones Programming functions	<b>18</b>
Initialisierung CODE Lock Initialisation CODE Lock Inizializzazione CODE Lock Inicialización CODE Lock Initialization CODE Lock	<b>6</b>	Modulaustausch Remplacement des modules Sostituzione moduli Sustitución módulo Module replacement	<b>22</b>
Programmierung CODE Lock Programmation CODE Lock Programmazione CODE Lock Programación CODE Lock Programming CODE Lock	<b>9</b>	Batteriewechsel Remplacement de batterie Sostituzione della batteria Cambio de batería Changing battery	<b>26</b>
Initialisierung RFID Lock Initialisation RFID Lock Inizializzazione RFID Lock Inicialización RFID Lock Initialization RFID Lock	<b>12</b>	Fehlersuche Détection d'erreurs Ricerca guasti Búsqueda de errores Troubleshooting	<b>27</b>

---

Die nachfolgende Montage- und Bedienungsanleitung ist als Sicherheitsmassnahme zwingend zu befolgen. Sie ist sämtlichen Beschäftigten zur Kenntnis zu bringen und von diesen zu beachten!  
**Benutzerhandbuch bitte nicht im Schrank aufbewahren!**

Les instructions suivantes de montage et d'utilisation doivent impérativement être appliquées comme mesures de sécurité. Elles doivent être portées à la connaissance de tous les collaborateurs et respectées de ceux-ci! **Ne pas conserver le manuel d'utilisation dans l'armoire!**

Le seguenti istruzioni per il montaggio e l'utilizzazione devono imperativamente essere rispettate per poter garantire le misure di sicurezza. L'intero personale ne deve essere a conoscenza e le deve rispettare! **Non conservare le istruzioni per l'uso nell'armadio!**

Como medida de seguridad, es imprescindible seguir las instrucciones del presente manual de instalación y uso. ¡Todos los operarios deberán conocerlas y respetarlas! **No conservar el Manual de Instrucciones dentro del armario.**

The following mounting and operating instructions must be observed for safety. All employees should be informed about them and observe them! **Please do not place the user manual in the cabinet!**



Warnhinweise  
 Attention  
 Attenzione  
 Precaución  
 Warning notices



+10 bis +40 °C  
 +10 à +40 °C  
 +10 a +40 °C  
 +10 a +40 °C  
 +10 to +40 °C



Beachten / Befolgen  
 Respecter / Suivre  
 Considerare / Seguire  
 Observar / Para seguir  
 To observe / To follow



Entsorgung  
 Elimination  
 Smaltimento  
 Eliminación  
 Disposal



Informationen  
 Informations  
 Informazioni  
 Información  
 Information



Vorsicht, ESD-Schutzmassnahmen einhalten!  
 Attention, nous vous prions de respecter les mesures de sécurité ESD!  
 Attenzione, vi preghiamo di rispettare le misure di sicurezza ESD!  
 Atención, mantenga las medidas de protección ESD.  
 Caution, please observe ESD protective measures!



Montageanleitung  
 Instruction de montage  
 Istruzioni per il montaggio  
 Instrucción de montaje  
 Assembly instructions

**PRODUKTÜBERSICHT CODE LOCK, RFID LOCK  
 APERÇU DU PRODUIT CODE LOCK, RFID LOCK  
 PANORAMICA DEL PRODOTTO CODE LOCK, RFID LOCK  
 VISTA GENERAL DEL PRODUCTO CODE LOCK, RFID LOCK  
 PRODUCT OVERVIEW CODE LOCK, RFID LOCK**



**CODE Lock**

siehe S. 6  
 voir p. 6  
 vedi p. 6  
 véase p. 6  
 see p. 6



LED

Zahlentasten 0–9  
 Touches numériques 0–9  
 Tasti numerici 0–9  
 Teclas numéricas 0–9  
 Numeric keys 0–9

ENTER-Taste  
 Touche ENTER  
 Tasto ENTER  
 Botón INTRO  
 ENTER button

USB-Anschluss  
 Raccordement USB  
 Connettore USB  
 Conexión USB  
 USB-port

Batteriefach  
 Compartiment pour batterie  
 Compartimento per batteria  
 Compartimento pilas  
 Battery compartment

Batterien 1,5 V, Typ AA (FR6)  
 Batteries 1,5 V, type AA (FR6)  
 Batterie 1,5 V, tipo AA (FR6)  
 Pilas 1,5 V, tipo AA (FR6)  
 Batteries 1,5 V, type AA (FR6)





**RFID Lock**

siehe S. 12  
voir p. 12  
vedi p. 12  
véase p. 12  
see p. 12



NFC Antenne  
NFC antenne  
NFC antenna  
NFC antena  
NFC antenna



**Programmier-Badge:**

Benutzer anlernen/löschen

**Badge programmable:**

Créer et supprimer un utilisateur

**Badge programmable:**

Imparare/cancellare l'utente

**Badge programmable:**

Crear y eliminar un usuario

**Programmable badge:**

Create/delete a user



**Benutzer-Badge**

Schrank öffnen

**Badge de l'utilisateur**

Ouvrez l'armoire

**Badge utente**

Aprire l'armadio

**Badge utente**

Aprire el armario

**User badge**

Open the cabinet

**LED:**



Freigabe Entriegelung  
Validation déblocage  
Conferma sblocco  
Confirmación desbloqueo  
Unlocking enabled



Abbruch/Fehler  
Interruption/erreurs  
Interruzione/errore  
Cancelar/error  
Cancel/error

**INITIALISIERUNG CODE LOCK  
 INITIALISATION CODE LOCK  
 INIZIALIZAZIONE CODE LOCK  
 INICIALIZACIÓN CODE LOCK  
 INITIALIZATION CODE LOCK**



**Auslieferungszustand:** LISTA Werkscode 1 2 3 4 5 ist werkseitig vorinstalliert.  
**Etat de livraison,** code LISTA 1 2 3 4 5 est préinstallé en usine.  
**Stato alla fornitura,** codice di fabbrica LISTA 1 2 3 4 5 è preinstallato.  
**Código de apertura preinstalado de fábrica** 1 2 3 4 5 está preinstalada de fábrica.  
**LISTA factory code** 1 2 3 4 5 and was preset at the factory.

Zum ersten Mal öffnen  
 Premier déverrouillage  
 Aperto per la prima volta  
 Abrir por primera vez  
 Unlocking for the first time

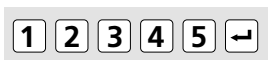

1 x Beep

**1**

**8-stellige Lock-ID eingeben  
 Introduire 8 caractères de Lock-ID  
 Inserire 8 cifre Lock-ID  
 Introducir 8 dígitos Lock-ID  
 Enter 8 digits of Lock-ID**

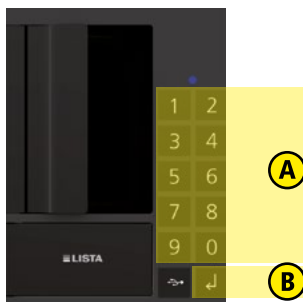

zum Beispiel / par exemple / per esempio /  
 por ejemplo / for example:  
 1 2 3 4 5 6 7 8 (8 digits)



(8 digits) 1 x Beep

Lock-ID wiederholen  
 Répéter Lock-ID  
 Ripetere Lock-ID  
 Repetir Lock-ID  
 Repeat Lock-ID

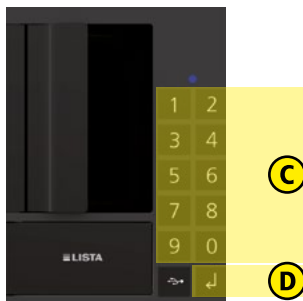

(8 digits) 3 x Beep

Ihre Lock-ID notieren:  
Noter votre Lock-ID:  
Nota il tuo Lock-ID:  
Tomar nota del Lock-ID:  
Note your Lock-ID:

**Lock-ID**



Lock-ID unbedingt in die freien Felder eintragen. Lock-ID kann nur mit LISTA Access Software geändert werden.  
Entrez Lock-ID absolument dans les champs libres. Le Lock-ID ne peut être modifiée avec le LISTA Access Software.  
Introducir Lock-ID a los campos libres. Il codice maestro può essere modificato solo con il LISTA Access Software.  
Inserisci Lock-ID assolutamente nei campi liberi. El código maestro sólo puede cambiarse con el LISTA Access Software.  
Insert Lock-ID necessarily into the free fields. The Lock-ID can only be changed with LISTA Access Software.

Mit der Lock-ID kann der Schrank nicht geöffnet werden. Diese dient lediglich der Programmierung.  
L'armoire ne peut pas être ouverte au moyen du Lock-ID. Celui-ci sert uniquement à la programmation.  
Il Lock-ID non permette di aprire l'armadio. Serve soltanto alla programmazione.  
Con el ID de Lock no puede abrirse el armario, solo sirve para la programación.  
The cabinet cannot be opened using the Lock-ID. It is intended for programming purposes only.

**BENUTZERCODES**  
**CODES UTILISATEURS**  
**CODICI UTENTE**  
**CÓDIGO USUARIOS**  
**USER CODES**



Benutzercodes in Tabelle eintragen  
Entrez le code d'utilisateur dans le tableau  
Introducir código de usuario en el cuadro  
Inserisci il codice utente nella tabella  
Insert user code in table

LISTA						
.....	<input type="text"/>	<input type="text"/>	<input type="text"/>	<input type="text"/>	<input type="text"/>	<input type="text"/>
.....	<input type="text"/>	<input type="text"/>	<input type="text"/>	<input type="text"/>	<input type="text"/>	<input type="text"/>
.....	<input type="text"/>	<input type="text"/>	<input type="text"/>	<input type="text"/>	<input type="text"/>	<input type="text"/>
.....	<input type="text"/>	<input type="text"/>	<input type="text"/>	<input type="text"/>	<input type="text"/>	<input type="text"/>
.....	<input type="text"/>	<input type="text"/>	<input type="text"/>	<input type="text"/>	<input type="text"/>	<input type="text"/>
.....	<input type="text"/>	<input type="text"/>	<input type="text"/>	<input type="text"/>	<input type="text"/>	<input type="text"/>
.....	<input type="text"/>	<input type="text"/>	<input type="text"/>	<input type="text"/>	<input type="text"/>	<input type="text"/>
.....	<input type="text"/>	<input type="text"/>	<input type="text"/>	<input type="text"/>	<input type="text"/>	<input type="text"/>
.....	<input type="text"/>	<input type="text"/>	<input type="text"/>	<input type="text"/>	<input type="text"/>	<input type="text"/>
.....	<input type="text"/>	<input type="text"/>	<input type="text"/>	<input type="text"/>	<input type="text"/>	<input type="text"/>
.....	<input type="text"/>	<input type="text"/>	<input type="text"/>	<input type="text"/>	<input type="text"/>	<input type="text"/>
.....	<input type="text"/>	<input type="text"/>	<input type="text"/>	<input type="text"/>	<input type="text"/>	<input type="text"/>
.....	<input type="text"/>	<input type="text"/>	<input type="text"/>	<input type="text"/>	<input type="text"/>	<input type="text"/>
.....	<input type="text"/>	<input type="text"/>	<input type="text"/>	<input type="text"/>	<input type="text"/>	<input type="text"/>
.....	<input type="text"/>	<input type="text"/>	<input type="text"/>	<input type="text"/>	<input type="text"/>	<input type="text"/>
.....	<input type="text"/>	<input type="text"/>	<input type="text"/>	<input type="text"/>	<input type="text"/>	<input type="text"/>
.....	<input type="text"/>	<input type="text"/>	<input type="text"/>	<input type="text"/>	<input type="text"/>	<input type="text"/>
.....	<input type="text"/>	<input type="text"/>	<input type="text"/>	<input type="text"/>	<input type="text"/>	<input type="text"/>
.....	<input type="text"/>	<input type="text"/>	<input type="text"/>	<input type="text"/>	<input type="text"/>	<input type="text"/>
.....	<input type="text"/>	<input type="text"/>	<input type="text"/>	<input type="text"/>	<input type="text"/>	<input type="text"/>
.....	<input type="text"/>	<input type="text"/>	<input type="text"/>	<input type="text"/>	<input type="text"/>	<input type="text"/>



**PROGRAMMIERUNG CODE LOCK  
 PROGRAMMATION CODE LOCK  
 PROGRAMMAZIONE CODE LOCK  
 PROGRAMACIÓN CODE LOCK  
 PROGRAMMING CODE LOCK**

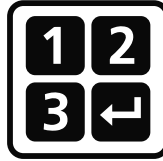

**2A**

**Benutzer anlernen  
 Enseigner aux utilisateurs  
 Enseñar a los usuarios  
 Insegnare usuario  
 Teach users**

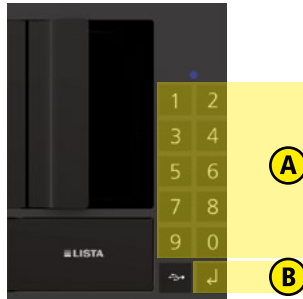

Lock-ID eingeben, (S. 7)  
 Introduire le Lock-ID, (S. 7)  
 Inserire il Lock-ID, (S. 7)  
 Introducir Lock-ID, (S. 7)  
 Enter Lock-ID, (S. 7)

**Lock-ID**



(8 digits)

**1 x Beep**

Taste 1 drücken  
 Appuyer sur la touche 1  
 Premere il tasto 1  
 Pulse el botón 1  
 Press the button 1

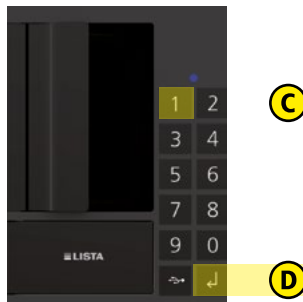

**1 x Beep**

Benutzercode eingeben  
 Introduire code utilisateur  
 Inserire codice utente  
 Introducir código usuario  
 Enter user code

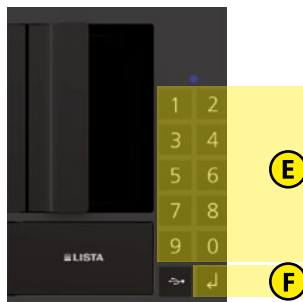

4–6 stellig  
 4–6 caractères  
 4–6 caratteri  
 4–6 dígitos  
 4–6 digits

zum Beispiel / par exemple / per esempio /  
 por ejemplo / for example:  
 1 2 3 4 5 6 (4–6 digits)



**3 x Beep**

**Benutzercode 2–100  
 Code utilisateur 2–100  
 Codici utente 2–100  
 Códigos usuarios 2–100  
 User codes 2–100**



Schritte A–F wiederholen  
 Répéter les opérations A–F  
 Ripetere i passi A–F  
 Repetir pasos A–F  
 Repeat steps A–F

PROGRAMMIERUNG CODE LOCK  
PROGRAMMATION CODE LOCK  
PROGRAMMAZIONE CODE LOCK  
PROGRAMACIÓN CODE LOCK  
PROGRAMMING CODE LOCK



2B

Benutzercodes entfernen  
Annuler codes utilisateurs  
Cancellare codice utente  
Anular códigos usuarios  
Delete user codes

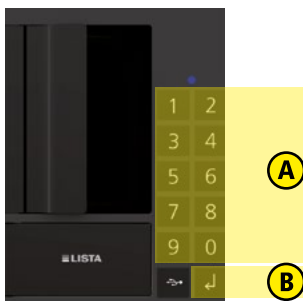

Lock-ID eingeben, (S. 7)  
Introduire le Lock-ID, (S. 7)  
Inserire il Lock-ID, (S. 7)  
Introducir Lock-ID, (S. 7)  
Enter Lock-ID, (S. 7)

Lock-ID



(8 digits)

1 x Beep

Taste 2 drücken  
Appuyer sur la touche 2  
Premere il tasto 2  
Pulse el botón 2  
Press the button 2

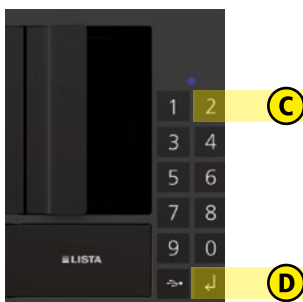

1 x Beep

Zu löschenden Benutzercode eingeben  
 Introduire code utilisateur par supprimer  
 Inserire codice utente per elimina  
 Introducir código usuario por borrar  
 Enter user code for delete

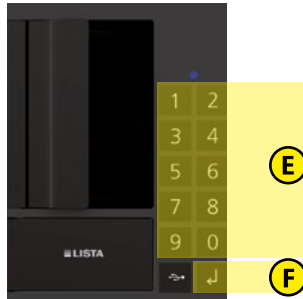

4–6 stellig  
 4–6 caractères  
 4–6 caratteri  
 4–6 dígitos  
 4–6 digits

zum Beispiel / par exemple / per esempio /  
 por ejemplo / for example:  
 1 2 3 4 5 6 (4–6 digits)



2 × Beep 

**Benutzercode 2–100**  
**Code utilisateur 2–100**  
**Codici utente 2–100**  
**Códigos usuarios 2–100**  
**User codes 2–100**



Schritte A–F wiederholen  
 Répéter les opérations A–F  
 Ripetere i passi A–F  
 Repetir pasos A–F  
 Repeat steps A–F

**INITIALISIERUNG RFID LOCK  
 INITIALISATION RFID LOCK  
 INIZIALIZAZIONE RFID LOCK  
 INICIALIZACIÓN RFID LOCK  
 INITIALIZATION RFID LOCK**



**Auslieferungszustand:** LISTA Werkscode 1 2 3 4 5 ist werkseitig vorinstalliert.  
**Etat de livraison,** code LISTA 1 2 3 4 5 est préinstallé en usine.  
**Stato alla fornitura,** codice di fabbrica LISTA 1 2 3 4 5 è preinstallato.  
**Código de apertura preinstalado de fábrica** 1 2 3 4 5 está preinstalada de fábrica.  
**LISTA factory code** 1 2 3 4 5 was preset at the factory.

Zum ersten Mal öffnen  
 Premier déverrouillage  
 Aperto per la prima volta  
 Abrir por primera vez  
 Unlocking for the first time

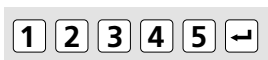

1 x Beep

**1**

**8-stellige Lock-ID eingeben  
 Introduire 8 caractères de Lock-ID  
 Inserire 8 cifre Lock-ID  
 Introducir 8 dígitos Lock-ID  
 Enter 8 digits of Lock-ID**

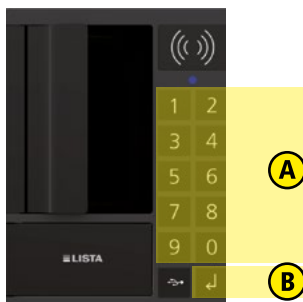

zum Beispiel / par exemple / per esempio /  
 por ejemplo / for example:  
 1 2 3 4 5 6 7 8 (8 digits)



(8 digits) 1 x Beep

Lock-ID wiederholen  
 Répéter Lock-ID  
 Ripetere Lock-ID  
 Repetir Lock-ID  
 Repeat Lock-ID

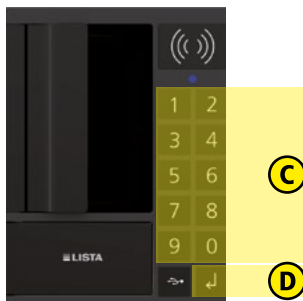

(8 digits) 3 x Beep

Ihre Lock-ID notieren:  
Noter votre Lock-ID:  
Nota il tuo Lock-ID:  
Tomar nota del Lock-ID:  
Note your Lock-ID:

**Lock-ID**



Lock-ID unbedingt in die freien Felder eintragen. Lock-ID kann nur mit LISTA Access Software geändert werden.  
Entrez Lock-ID absolument dans les champs libres. Le Lock-ID ne peut être modifiée avec le LISTA Access Software.  
Introducir Lock-ID a los campos libres. Il codice maestro può essere modificato solo con il LISTA Access Software.  
Inserisci Lock-ID assolutamente nei campi liberi. El código maestro sólo puede cambiarse con el LISTA Access Software.  
Insert Lock-ID necessarily into the free fields. The Lock-ID can only be changed with LISTA Access Software.

Mit der Lock-ID kann der Schrank nicht geöffnet werden. Diese dient lediglich der Programmierung.  
L'armoire ne peut pas être ouverte au moyen du Lock-ID. Celui-ci sert uniquement à la programmation.  
Il Lock-ID non permette di aprire l'armadio. Serve soltanto alla programmazione.  
Con el ID de Lock no puede abrirse el armario, solo sirve para la programación.  
The cabinet cannot be opened using the Lock-ID. It is intended for programming purposes only.

**PROGRAMMIERUNG RFID LOCK  
 PROGRAMMATION RFID LOCK  
 PROGRAMMAZIONE RFID LOCK  
 PROGRAMACIÓN RFID LOCK  
 PROGRAMMING RFID LOCK**



**2**

**Programmier-Badge erstellen  
 Réalisez badge programmable  
 Realizar badge programmable  
 Realizzare badge programmabile  
 Create programmable badge**

8-stelligen Lock-ID erneut eingeben  
 Introduire 8 caractères Lock-ID à nouveau  
 Inserire 8 cifre Lock-ID nuovamente  
 Introducir 8 dígitos código maestro de nuevo  
 Enter 8 digits of Lock-ID again

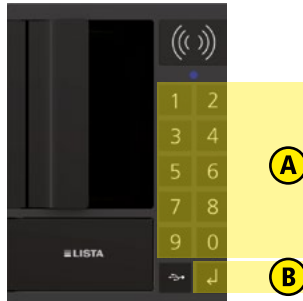

Lock-ID eingeben, (S. 13)  
 Introduire le Lock-ID, (S. 13)  
 Inserire il Lock-ID, (S. 13)  
 Introducir Lock-ID, (S. 13)  
 Enter Lock-ID, (S. 13)

**Lock-ID**



(8 digits)

**1 x Beep**

Programmier-Badge an Antenne halten  
 Tenez la badge à l'antenne  
 Tieni la badge l'antenna  
 Colocar la badge sobre el sensor  
 Hold the badge to the antenna



max. 5 Programmier-Badges möglich  
 max. 5 badges programmable possible  
 max. 5 badges programmabile possibile  
 max. 5 badges programmabile possibile  
 max. 5 programmable badges possible

**3 x Beep**

**Programmier-Badge 2-5  
 Badge programmable 2-5  
 Badge programmabile 2-5  
 Badge programmabile 2-5  
 Programmable badge 2-5** Schritte A-C wiederholen  
 Répéter les opérations A-C  
 Ripetere i passi A-C  
 Repetir pasos A-C  
 Repeat steps A-C

### 3A

Benutzer-Badge hinzufügen  
 Programmation des badge de l'utilisateur  
 Programmazione del badge utente  
 Programación badge usuario  
 Programming user badge



Programmier-Badge an Antenne halten.  
 Tenez la badge principale à l'antenne.  
 Tieni la badge programmabile per l'antenna.  
 Colocar la badge maestra sobre el sensor.  
 Hold the master badge to the antenna.

1 x Beep



Benutzer-Badge an Antenne halten.  
 Tenez la badge de l'utilisateur à l'antenne.  
 Tieni la badge utente per l'antenna.  
 Colocar la badge usuario sobre el sensor.  
 Hold user badge to the antenna.



Badge ist angelehrt  
 Le badge est supprimé  
 Badge è imparato  
 La badge queda programada  
 The badge is recognised

3 x Beep

max. Benutzer-Badge: 100  
 max. Badge utilisateur: 100  
 max. Badge utente: 100  
 max. Badge usuarios: 100  
 max. User Badge: 100



Schritte A–B wiederholen  
 Répéter les opérations A–B  
 Ripetere i passi A–B  
 Repetir pasos A–B  
 Repeat steps A–B



**3B**

Benutzer löschen  
Supprimer l'utilisateur  
Elimina utente  
Borrar usuario  
Delete user



Programmier-Badge an Antenne halten.  
Tenez la badge principale à l'antenne.  
Tieni la badge maestra per l'antenna.  
Colocar la badge maestra sobre el sensor.  
Hold the master badge to the antenna.

1 x Beep



Benutzer-Badge an Antenne halten.  
Tenez badge de l'utilisateur à l'antenne.  
Tieni badge utente per l'antenna.  
Colocar badge usuario sobre el sensor.  
Hold user badge to the antenna.



Badge ist gelöscht  
Le badge est supprimé  
Badge é cancellato  
La información de la badge se borra  
The badge is deleted

2 x Beep

Beim RFID Lock kann auch mit den Funktionen des CODE Locks gearbeitet werden, s. S. 8–9.  
Vous pouvez utiliser le RFID Lock avec les fonctions du CODE Lock. Voir pages 8–9.  
È possibile lavorare con RFID Lock anche con le funzioni di CODE Lock. Vedi pagina 8–9.  
Con las funciones del CODE Lock es también posible utilizar el RFID Lock. Véanse pág. 8 y 9.  
You can use the RFID Lock with the functions of the CODE Lock. See pages 8–9.



**PROGRAMMIERUNG FUNKTIONEN**  
**PROGRAMMATION FONCTIONS**  
**PROGRAMMAZIONE FUNZIONI**  
**PROGRAMACIÓN FUNCIONES**  
**PROGRAMMING FUNCTIONS**

**Auslieferungszustand wiederherstellen**  
**Réinitialiser l'état de Livraison**  
**Ricreare stato di consegna**  
**Regenerar estado en el momento de la entrega**  
**Restore delivery status**

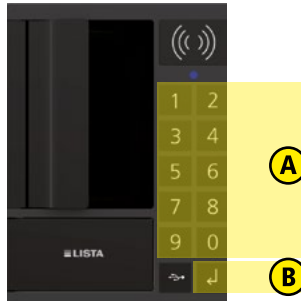

Lock-ID eingeben, (S. 7/13)  
 Introduire le Lock-ID, (S. 7/13)  
 Inserire il Lock-ID, (S. 7/13)  
 Introducir Lock-ID, (S. 7/13)  
 Enter Lock-ID, (S. 7/13)

**Lock-ID**



(8 digits)

**1 x Beep**



**Achtung! Alle Einstellungen werden gelöscht!**  
**Attention! Tous les paramètres seront effacés!**  
**Attenzione! Tutte le impostazioni vengono cancellate!**  
**Atención, ¡se eliminarán todos los ajustes!**  
**Warning! All parameters will be deleted!**

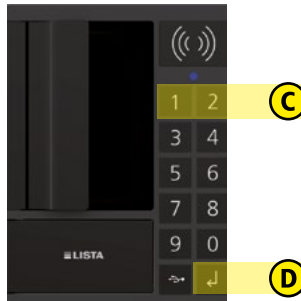

Zahl eingeben: 1212121212  
 Introduire le nombre : 121212121212  
 Inserire il numero: 1212121212  
 Introducir número: 121212121212  
 Enter number: 1212121212



**1 x Beep**

30 s warten  
 Attendre 30 s  
 Attendere 30 s  
 Espere 30 s  
 Wait 30 s



**3 x Beep** = gelöscht  
 annulé  
 cancelato  
 borrado  
 deleted

**PROGRAMMIERUNG FUNKTIONEN**  
**PROGRAMMATION FONCTIONS**  
**PROGRAMMAZIONE FUNZIONI**  
**PROGRAMACI3N FUNCIONES**  
**PROGRAMMING FUNCTIONS**

---

**Ton ausschalten**  
**Désactiver le son**  
**Disattivare il suono**  
**Desactiva el sonido**  
**Turn off sound**

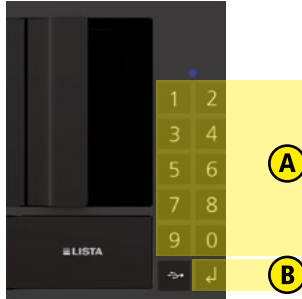

Lock-ID eingeben, (S. 7/13)  
Introduire le Lock-ID, (S. 7/13)  
Inserire il Lock-ID, (S. 7/13)  
Introducir Lock-ID, (S. 7/13)  
Enter Lock-ID, (S. 7/13)

**Lock-ID**



(8 digits)

Taste 8 drücken  
Appuyer sur la touche 8  
Premere il tasto 8  
Pulse el botón 8  
Press the button 8



**Ton leise**  
**Son bas**  
**Suono basso**  
**Sonido bajo**  
**Sound low**

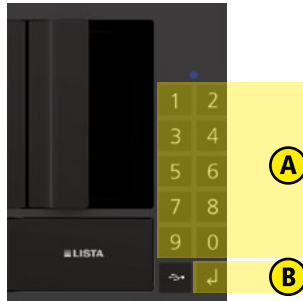

Lock-ID eingeben, (S. 7/13)  
 Introduire le Lock-ID, (S. 7/13)  
 Inserire il Lock-ID, (S. 7/13)  
 Introducir Lock-ID, (S. 7/13)  
 Enter Lock-ID, (S. 7/13)

**Lock-ID**



(8 digits)

Taste 9 drücken  
 Appuyer sur la touche 9  
 Premere il tasto 9  
 Pulse el botón 9  
 Press the button 9



**PROGRAMMIERUNG FUNKTIONEN**  
**PROGRAMMATION FONCTIONS**  
**PROGRAMMAZIONE FUNZIONI**  
**PROGRAMACI3N FUNCIONES**  
**PROGRAMMING FUNCTIONS**

**Ton laut**  
**Son fort**  
**Suono forte**  
**Sonido fuerte**  
**Sound loud**

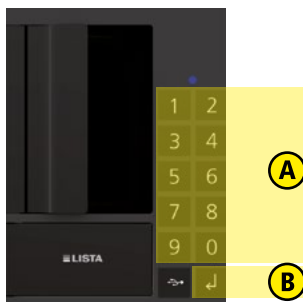

Lock-ID eingeben, (S. 7/13)  
 Introduire le Lock-ID, (S. 7/13)  
 Inserire il Lock-ID, (S. 7/13)  
 Introducir Lock-ID, (S. 7/13)  
 Enter Lock-ID, (S. 7/13)

**Lock-ID**



(8 digits)

Taste 0 drücken  
 Appuyer sur la touche 0  
 Premere il tasto 0  
 Pulse el botón 0  
 Press the button 0



STANDARD ESD SCHUTZ  
PROTECTION ESD STANDARD  
PROTEZIONE STANDARD ESD  
PROTECCIÓN ESD ESTÁNDAR  
STANDARD ESD PROTECTION

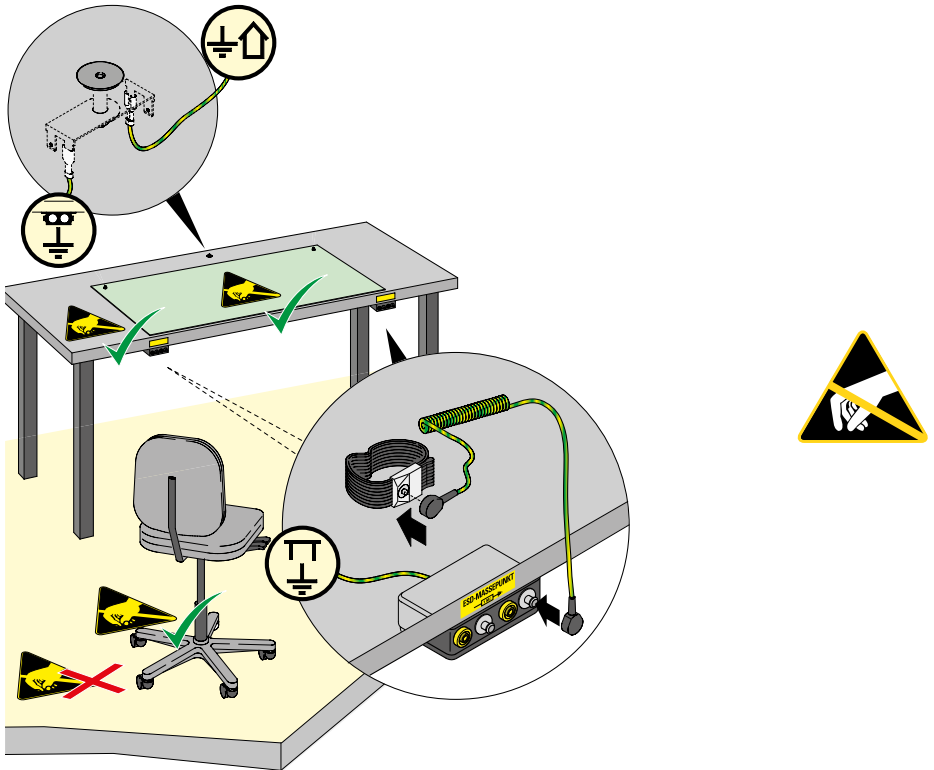

**MODULAUSTAUSCH  
REPLACEMENT DES MODULES  
SOSTITUZIONE MODULI  
SUSTITUCIÓN MÓDULO  
MODULE REPLACEMENT**

---

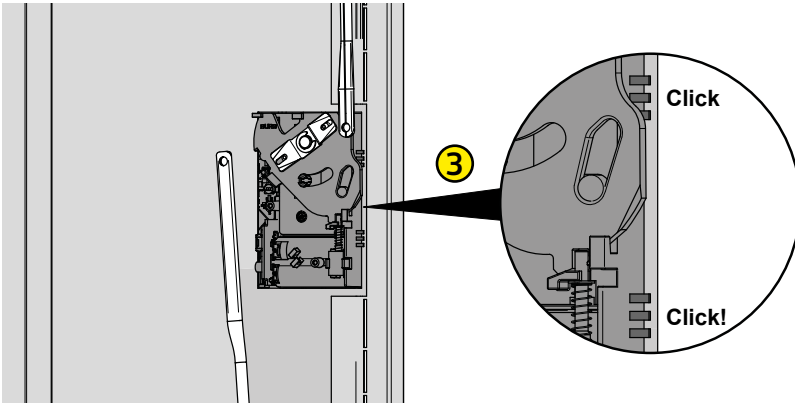
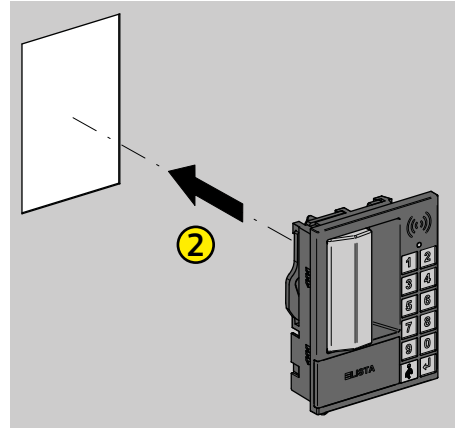
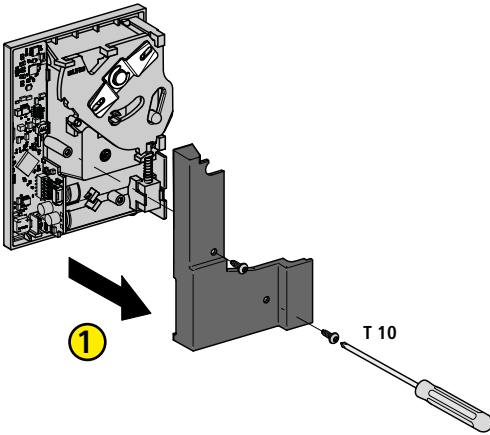

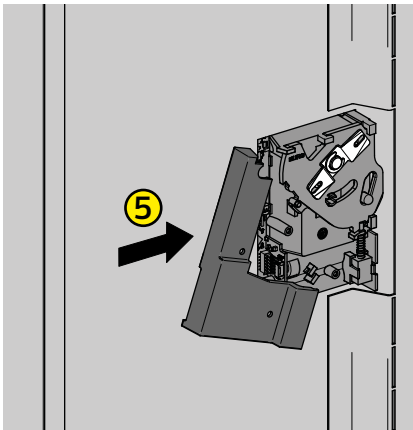
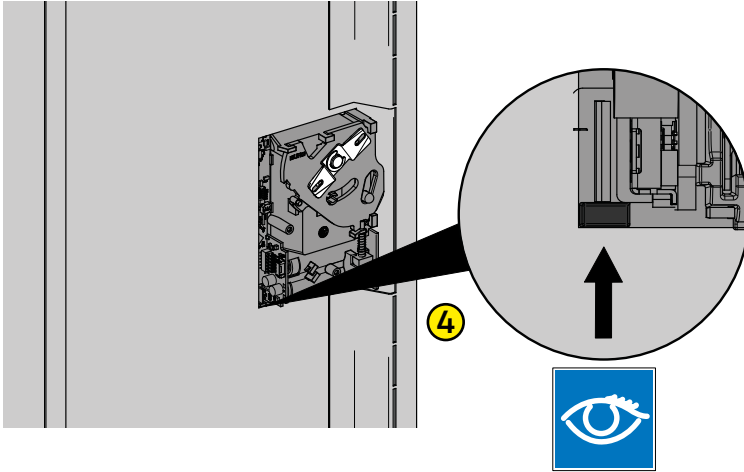

MODULAUSTAUSCH  
REPLACEMENT DES MODULES  
SOSTITUZIONE MODULI  
SUSTITUCIÓN MÓDULO  
MODULE REPLACEMENT

---

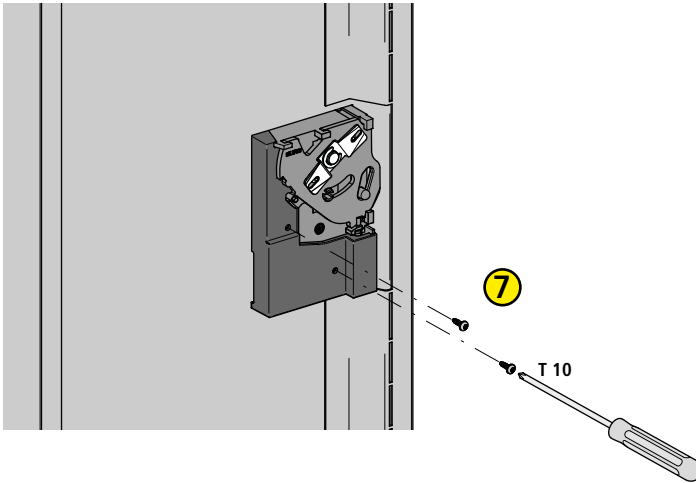
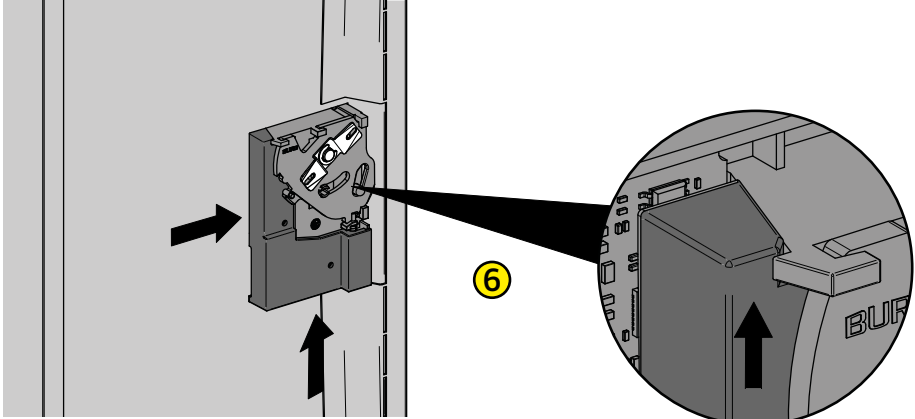



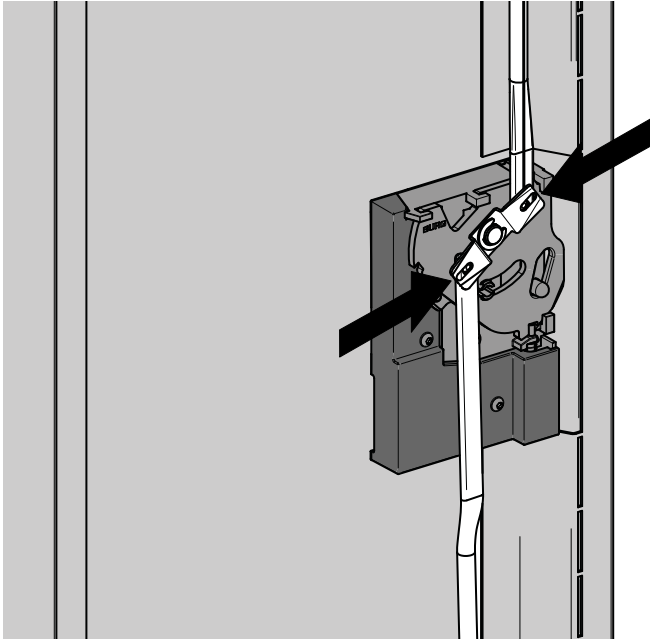

**BATTERIEWECHSEL  
REEMPLACEMENT DE BATTERIE  
SOSTITUZIONE DELLA BATTERIA  
CAMBIO DE BATERÍA  
CHANGING BATTERY**



Batterielebensdauer: bis zu 1 Jahr je nach Nutzungs-  
frequenz.

Durée de vie des piles : jusqu'à 1 an en fonction de  
la fréquence d'utilisation.

Durata della batteria: fino a 1 anno a seconda della  
frequenza di utilizzo.

Vida útil de la pila: hasta 1 año en función de la fre-  
cuencia de uso.

Battery life: up to 1 year depending on frequency of  
use.

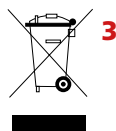

Auf Polarität achten  
Prendre garde à la polarité  
Tenere conto della polarità  
Respetar las polaridades  
Observe polarity

Codes bleiben gespeichert  
Les codes restent mémorisés  
I codici rimangono memorizzati  
Los códigos permanecen memorizados  
Codes remain saved

**FEHLERSUCHE  
DÉTECTION D'ERREURS  
RICERCA GUASTI  
BÚSQUEDA DE ERRORES  
TROUBLESHOOTING**

<b>Fehler</b>	<b>mögliche Ursache</b>	<b>Behebung</b>
<b>Schloss reagiert nicht</b>	Keine Batterien vorhanden	Batterien einsetzen
	Batterien falsch eingesetzt	Batterien korrekt einsetzen
	Batterien leer	Neue Batterien einsetzen
	Systemfehler	Batterien ausbauen und wieder einbauen
	Schloss defekt	Schloss austauschen
<b>Lock-ID kann nicht eingegeben werden</b>	Die zwei Codes sind nicht identisch	Siehe Lock-ID hinzufügen
	Code hat nicht 8 Ziffern	Code mit 8 Ziffern eingeben
<b>Benutzercode kann nicht eingegeben werden</b>	Code hat nicht 4–6 Ziffern	Code mit 4–6 Ziffern eingeben
	Die Taste 1 für Benutzer hinzufügen wurde nicht gedrückt	Siehe Benutzer hinzufügen
<b>Drehknopf kann nicht gedreht werden</b>	Drehknopf wurde zu früh gedreht und blockiert den Magnetanker	Drehknopf erst drehen, wenn die grüne LED leuchtet
	Batterie leer und Magnet zieht nicht mehr an	Neue Batterien einsetzen
<b>Beeper arbeitet nicht</b>	Funktion Beeper ist ausgeschaltet	Siehe Lautstärke des Beepers einstellen
<b>LED arbeitet nicht</b>	LED defekt	Schloss austauschen
<b>LED blitzt rot auf und kurzes akustisches Signal</b>	Batterien leer	Neue Batterien einsetzen
<b>User Badge öffnet das Schloss nicht</b>	Badge ist noch nicht gespeichert	Siehe Benutzer hinzufügen, mit Master Badge
	Badge ist schon als Master Badge angelernt	User Badge verwenden
<b>User Badge kann nicht angelernt werden</b>	User Badge ist nicht kompatibel	RPID Standard vom User Badge prüfen

# FEHLERSUCHE

## DÉTECTION D'ERREURS

### RICERCA GUASTI

### BÚSQUEDA DE ERRORES

### TROUBLESHOOTING

---

Erreurs	Causes possibles	Remèdes
<b>La serrure ne réagit pas</b>	Aucune pile n'a été insérée	Insérer les piles
	Insertion incorrecte des piles	Insérer correctement les piles
	Piles épuisées	Insérer de nouvelles piles
	Erreur système	Retirer et remettre en place les piles
	Serrure défectueuse	Remplacer la serrure
<b>Lock-ID ne peut pas être saisi</b>	Les deux codes ne sont pas identiques	Voir ajouter Lock-ID
	Code n'a pas 8 chiffres	Saisir le code à 8 chiffres
<b>Le code d'utilisateur ne peut pas être saisi</b>	Code n'a pas 4–6 chiffres	Saisir le code à 4–6 chiffres
	La touche 1 pour Ajouter utilisateur n'a pas été enfoncée	Voir ajouter utilisateur
<b>Le bouton rotatif ne peut pas être tourné</b>	Le bouton rotatif a été tourné trop tôt et bloque l'induit magnétique	Tourner le bouton rotatif seulement une fois que la LED verte s'est allumée
	Pile épuisée et l'aimant ne réagit plus	Insérer de nouvelles piles
<b>Le beeper ne fonctionne pas</b>	La fonction beeper est désactivée	Voir régler le volume sonore du beeper
<b>LED ne fonctionne pas</b>	LED défectueuse	Remplacer la serrure
<b>Voyant LED clignote en rouge et bref signal sonore</b>	Piles épuisées	Insérer de nouvelles piles
<b>User badge ne peut pas ouvrir la serrure</b>	Le badge n'a pas encore été enregistré	Voir ajouter utilisateur avec master badge
	Le badge a déjà été initié comme master badge	Utiliser user badge
<b>User badge ne peut pas être initié</b>	User badge n'est pas compatible	Vérifier RFID Standard du user badge

<b>Guasto</b>	<b>Possibile causa</b>	<b>Rimedio</b>
<b>La serratura non risponde</b>	Nessuna batteria presente	Inserire le batterie
	Batterie inserite in modo errato	Inserire correttamente le batterie
	Batterie scariche	Inserire le batterie nuove
	Errore di sistema	Rimuovere e rimontare le batterie
	Serratura difettosa	Sostituire la serratura
<b>Il Lock-ID non può essere inserito</b>	I due codici non sono identici	Vedi aggiungere il Lock-ID
	Il codice ha non 8 cifre	Inserire il codice di 8 cifre
<b>Il codice utente può essere inserito</b>	Il codice ha non 4–6 cifre	Inserire il codice di 4–6 cifre
	Il tasto 1 per Aggiungi utente non è stato premuto	Vedi aggiungere utente
<b>La manopola non può essere girata</b>	La manopola è stata girata troppo presto e blocca l'ancoraggio magnetico	Girare la manopola quando il LED si accende in verde
	La batteria è vuota e il magnete non attira più	Inserire le batterie nuove
<b>Il segnalatore acustico non funziona</b>	La funzione del segnalatore acustico è spento	Vedi impostare il volume del segnalatore acustico
<b>Il LED non funziona</b>	LED difettoso	Sostituire la serratura
<b>Il LED lampeggia in rosso ed emette un breve segnale acustico</b>	Batterie scariche	Inserire le batterie nuove
<b>Lo user badge non apre la serratura</b>	Badge non è ancora memorizzato	Vedi aggiungere utente con master badge
	Il badge è imparato come master badge	Utilizzare lo user badge
<b>Lo user badge non può essere programmato</b>	Lo user badge non è compatibile	Controllare RPID Standard dallo user badge

# FEHLERSUCHE

## DÉTECTION D'ERREURS

### RICERCA GUASTI

#### BÚSQUEDA DE ERRORES

#### TROUBLESHOOTING

---

Error	Causa posible	Eliminación
<b>La cerradura no reacciona</b>	No existe ninguna pila	Insertar pilas
	No existe ninguna pila	Insertar las pilas correctamente
	Pilas descargadas	Insertar pilas nuevas
	Error de sistema	Sacar y volver a instalar las pilas
	Cerradura defectuosa	Sustituir la cerradura
<b>No se puede entrar el código maestro</b>	Los dos códigos no son idénticos	Véase agregar código maestro
	El código no tiene 8 cifras	Entrar código de 8 cifras
<b>No se puede entrar el código de usuario</b>	El código no tiene 4 a 6 cifras	Entrar código de 4 a 6 cifras
	No se ha pulsado la tecla 1 para usuario	Véase agregar usuario
<b>El botón giratorio no se puede girar</b>	El botón giratorio se ha girado demasiado temprano y está bloqueando el inductor magnético	Apenas girar el botón giratorio cuando el LED verde esté iluminado
	Pila descargada e imán ya no atrae	Insertar pilas nuevas
<b>El biper no funciona</b>	Funcionamiento de biper está apagado	Véase ajustar el volumen del biper
<b>El LED no funciona</b>	LED defectuoso	Sustituir la cerradura
<b>El LED parpadea en rojo y se emite una breve señal acústica</b>	Pilas descargadas	Insertar pilas nuevas
<b>User badge no abre la cerradura</b>	Badge todavía no está almacenado	Véase agregar usuario con master badge
	Badge ya está entrenado como master badge	Usar user badge
<b>User badge no se puede entrenar</b>	User badge no es compatible	Controlar RPID Standard del user badge

<b>Error</b>	<b>Possible cause</b>	<b>Rectification</b>
<b>Lock does not react</b>	No batteries installed	Install batteries
	Batteries installed incorrectly	Install batteries correctly
	Batteries discharged	Install new batteries
	System error	Remove batteries and re-fit
	Lock faulty	Replace lock
<b>It is not possible to enter Lock-ID</b>	The two codes are not identical	See adding Lock-ID
	Code does not have 8 digits	Enter code with 8 digits
<b>It is not possible to enter user code</b>	Code does not have 4–6 digits	Enter code with 4–6 digits
	Button 1 for adding user has not been pressed	See adding user
<b>Rotary knob cannot be rotated</b>	Rotary knob was rotated too early and is blocking the solenoid armature	Only rotate rotary knob once the green LED is illuminated
	Battery discharged and solenoid no longer energises	Install new batteries
<b>Beeper does not work</b>	Beeper function is switched off	See adjusting volume of the beeper
<b>LED does not work</b>	LED faulty	Replace lock
<b>The LED will blink red and a short acoustic signal will sound</b>	Batteries discharged	Install new batteries
<b>User badge does not open the lock</b>	Badge has not yet been saved	See adding user with master badge
	Badge has already been taught-in as master badge	Use user badge
<b>User badge cannot be taught-in</b>	User badge is not compatible	Check RPID standard of the user badge

Lista AG  
Fabrikstrasse 1  
CH-8586 Erlen  
Telefon +41 71 649 21 11  
Telefax +41 71 649 22 03  
info@lista.com  
www.lista.com



[www.lista.com](http://www.lista.com)